

©WENZHOU WELFNOBL ELECTRIC CO.,LTD.

All rights reserved.

Disclaimer: The appearance, color and parameters of the products listed in this catalogue are for reference only, whichever is issued by WELFNOBL.

WELFNOBL reserves the right to modify or cancel the relevant parameters of this catalogue without prior notice. If you have any questions, please contact our sales representative.

2023 VERSION

WELFNOBL®



INNOVATION



SERVICE



WIN-WIN

AUTOMOTIVE MODIFICATION MANUFACTURER

WELFNOBL®

WENZHOU WELFNOBL ELECTRIC CO.,LTD.

Address: Dongao Industrial Zone, Liushi, Yueqing, Wenzhou, Zhejiang, China

Tel: +86-577-61776877 Mobile/Wechat: +86 180 6633 0701

Website: <https://chinaweina.en.alibaba.com> www.welfnobl.com

Email: wn833@welfnobl.com Skype: [abbeycon827@outlook.com](https://www.skype.com/people/abbeycon827)



Website



Wechat

WENZHOU WELFNOBL ELECTRIC CO.,LTD.

Company profile



We are committed to providing customers with high-quality products, reasonable prices, good services, and solving problems for customers.



Professional automotive product manufacturer



Founded in 2015, Wenzhou Welfnobl Electric Co., Ltd. has been providing electrical parts for automotive, RVs, camping cars and marine markets. Today Welfnobl Electric has become a veteran manufacturer producing car charger, cigarette lighter, sockets, fuse blocks, bus bars, switch panels, and other electrical products under the "Welfnobl" Brand, serving more than 20000 customers around the world.

Based in Wenzhou Zhejiang, with around 3,500 square meters factory, Which contain sixteen production lines including patch production, reflow soldering, plug-in production, mold injection, assembly production and packaging. we have a strong base in Product Design and Engineering, Manufacturing, Quality Control and Customer Service. Our R&D team has been rewarded more than 12 patents in the past 5 years and all of our products have been carefully designed, tested and certificated before mass production.

Wenzhou Welfnobl Electric Co., Ltd stands as a beacon of excellence in the heart of the automotive sector. With years of dedicated experience, we have evolved into a leading manufacturer that consistently pushes the boundaries of technological advancement. Our commitment to quality, design, and functionality sets us apart as a trusted partner for all your automotive electrical needs.

At Wenzhou Welfnobl Electric Co., Ltd, we invite you to explore our range of USB car chargers, automotive switches, and car electronics that epitomize the fusion of technology and automotive excellence. Join us in embracing the future of driving.



INNOVATION



SERVICE



WIN-WIN



PRODUCTION ABILITY

With 12 years of experience in producing car chargers switches and related products, We are dedicated to providing our customers with reliable products that conform to the highest standards of quality. Our products are made with the finest materials and tested by qualified professionals to ensure the best performance. We are committed to providing quality products and services to our customers.

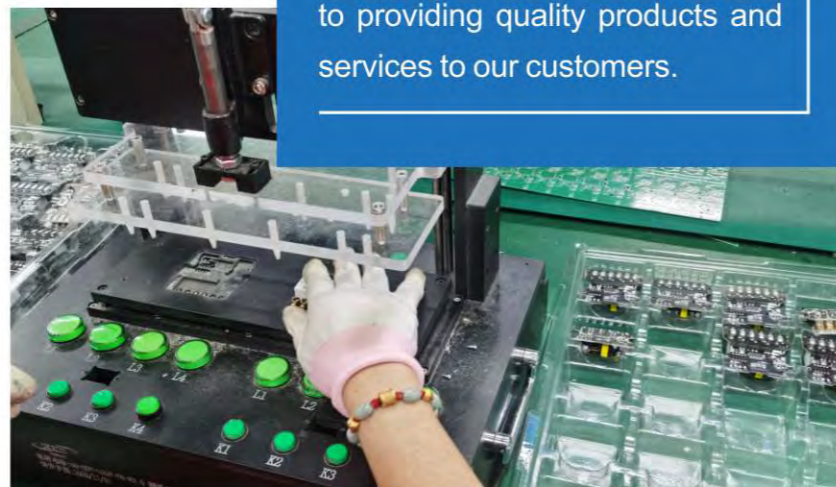

16 Production lines

3500 m² Plant areas



Automated production workshop

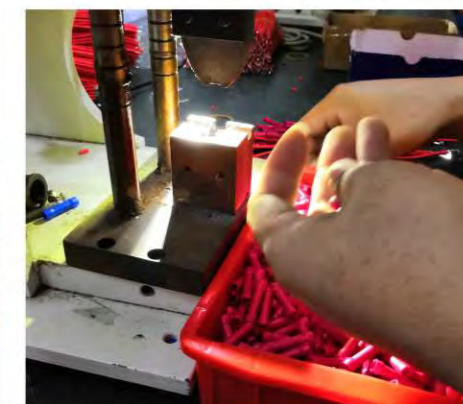

Enterprise honor

We have CE certification,
ROHS certification,
ISO9001 certification,
Chinese CCC certification etc.

CERTIFICATION QUALIFICATION



Patents we have got

3 patents for innovation,
4 patents for utility model and 5 patents for design





ROCKER SWITCH PAGE /08



USB CHARGER PAGE /14



DIGITAL METER PAGE /24



CIGARETTE LIGHTER PAGE /29



SWITCH PANEL PAGE /33



SPECIAL VEHICLE CHARGER PAGE /61



BATTERY SWITCH PAGE /67



FUSE BLOCK PAGE /68



MOTORCYCLE USB CHARGER PAGE /75



WATER DROPLET SWITCH PAGE /80



RV LOCK PAGE /83



BUSBAR PAGE /84

COMMITTED TO SOLVING
PROBLEMS FOR CUSTOMERS
AND PROVIDING
ONE-STOP SERVICE

IB-	1 A	2 Base	3 Poles	4 Cover	5 Light	6 Terminal Number	7 Electrical Functions	8 Lens Colors
-----	--------	-----------	------------	------------	------------	----------------------	---------------------------	------------------

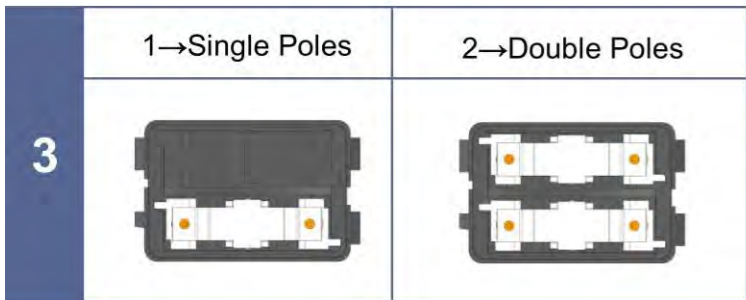
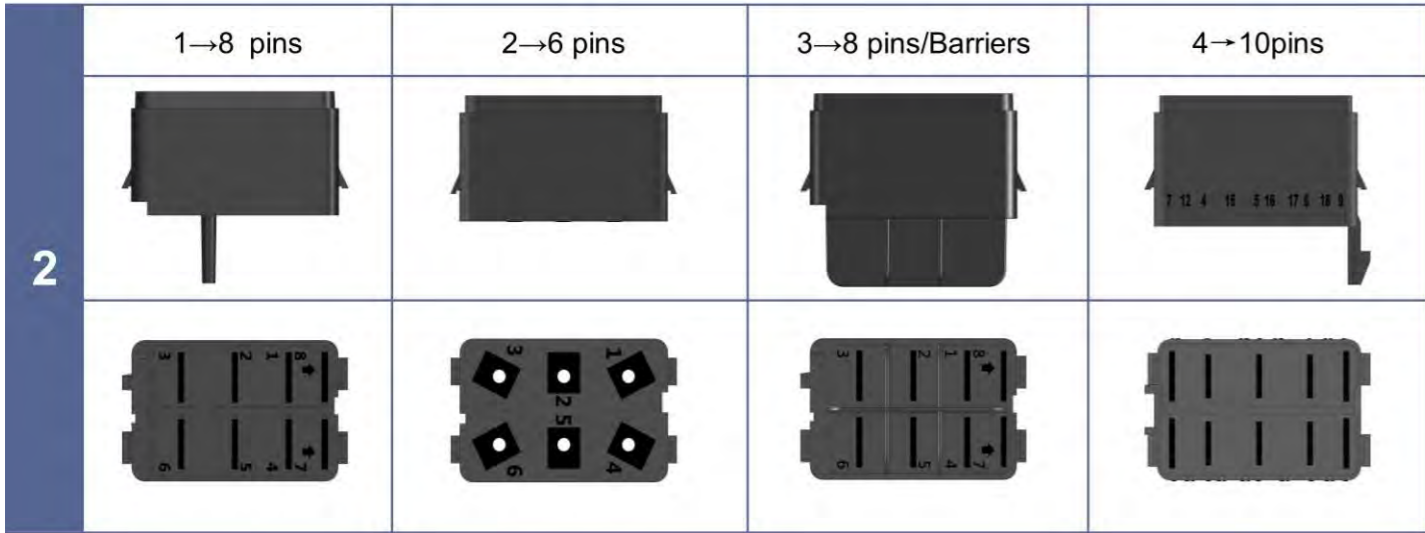

7

- A → ON-OFF
- B → (ON)-OFF
- C → ON-ON
- D → (ON)-ON
- E → ON-OFF-ON
- F → (ON)-OFF-ON
- G → (ON)-OFF-(ON)
- H → ON-ON-ON
- I → ON-ON-OFF
- J → (ON)-ON-OFF
- K → (ON)-ON-ON

8

B
R
G
BL
OR
W



ROCKER SWITCH

Electrical:

Rating	Dielectric Strength	Insulation Resistance	Life	Endurance	Operating Temperature	Terminals	Lighted
12V 20A 24V 10A DC 125V 15A 250V 10A AC	1500 Volts RMS	50 Megohms	10000 cycles	50000 cycles minimum	-40°C to + 85°C	Brass or copper/silver plate 1/4" (6.3mm)	Incandescent- rated 10,000 hours Neon - rated 25,000 hours LED - rated 50,000 hours

Single poles circuit

NO.	Electrical	Type	Pin1	Pin2	Pin3	Pin4	Pin5	Pin6
A	ON-OFF	SPST		Power in	Power out			
B	(ON)-OFF	SPST		Power in	Power out			
C	ON-ON	SPDT	Power out	Power in	Power out			
D	(ON)-ON	SPDT	Power out	Power in	Power out			
E	ON-OFF-ON	SPDT	Power out	Power in	Power out			
F	(ON)-OFF-ON	SPDT	Power out	Power in	Power out			
G	(ON)-OFF-(ON)	SPDT	Power out	Power in	Power out			

Double poles circuit

NO.	Electrical	Type	Pin1	Pin2	Pin3	Pin4	Pin5	Pin6
A	ON-OFF	DPST		Power in	Power out		Power in	Power out
B	(ON)-OFF	DPST		Power in	Power out		Power in	Power out
C	ON-ON	DPDT	Power out	Power in	Power out	Power out	Power in	Power out
D	(ON)-ON	DPDT	Power out	Power in	Power out	Power out	Power in	Power out
E	ON-OFF-ON	DPDT	Power out	Power in	Power out	Power out	Power in	Power out
F	(ON)-OFF-ON	DPDT	Power out	Power in	Power out	Power out	Power in	Power out
G	(ON)-OFF-(ON)	DPDT	Power out	Power in	Power out	Power out	Power in	Power out
H	ON-ON-ON	DPTT	Power out	Power in	Power out	Power out	Power in	Power out
I	ON-ON-OFF	DPDT		Power in	Power out		Power in	Power out
J	(ON)-ON-OFF	DPDT		Power in	Power out		Power in	Power out
K	(ON)-ON-ON	DPTT	Power out	Power in	Power out	Power out	Power in	Power out

Product Size

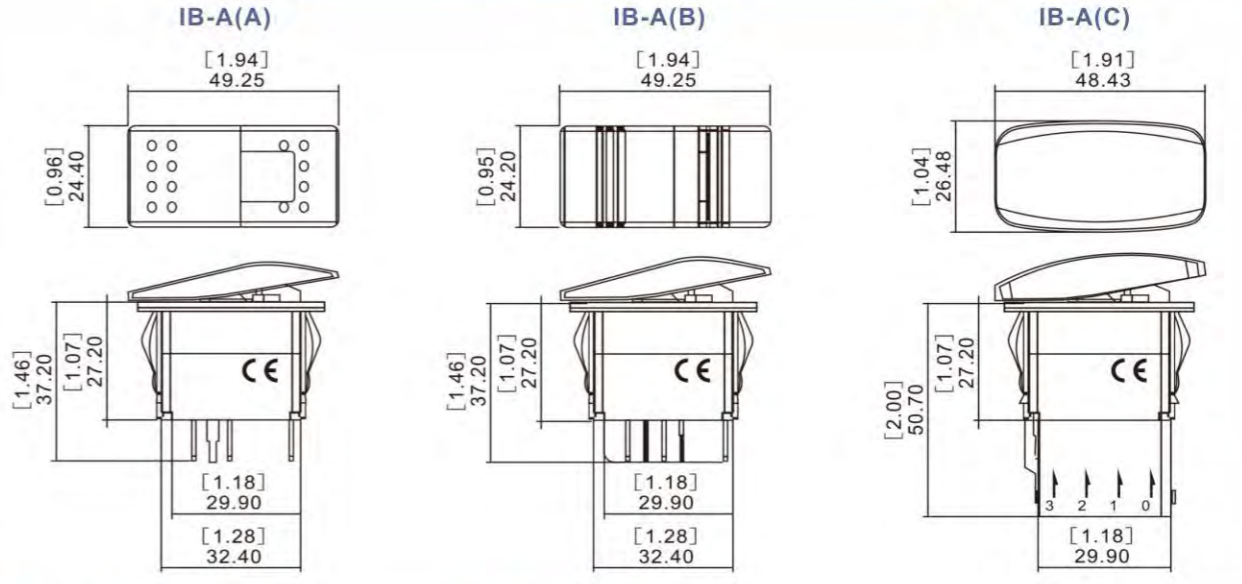

PIN TYPE



11PIN



12PIN



2PIN



3PIN



4PIN



5PIN



7PIN



10PIN

INSTALLATION DETAILS

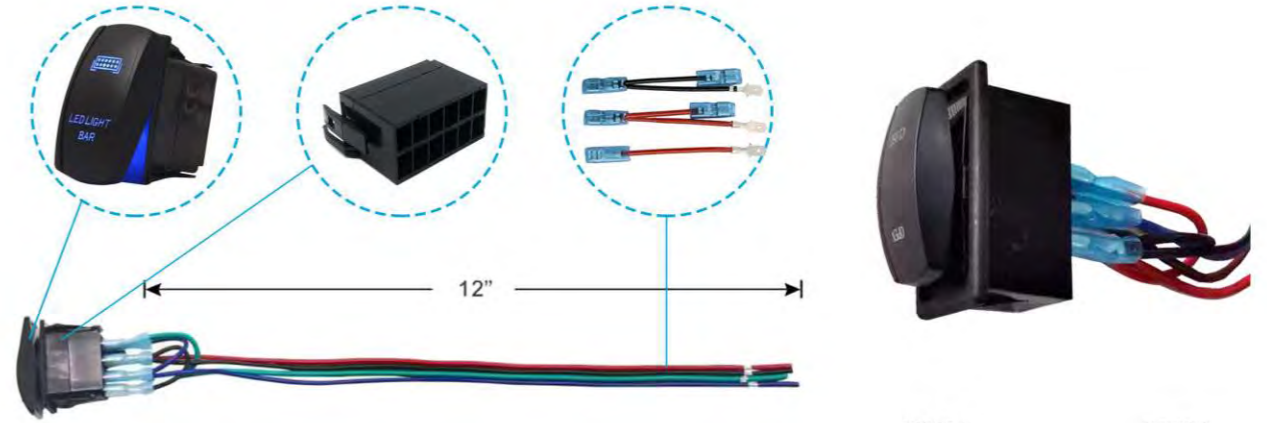

LED Light Bar Wiring Harness
(Rocker On/Off Switch Series)
Diagram and Instructions

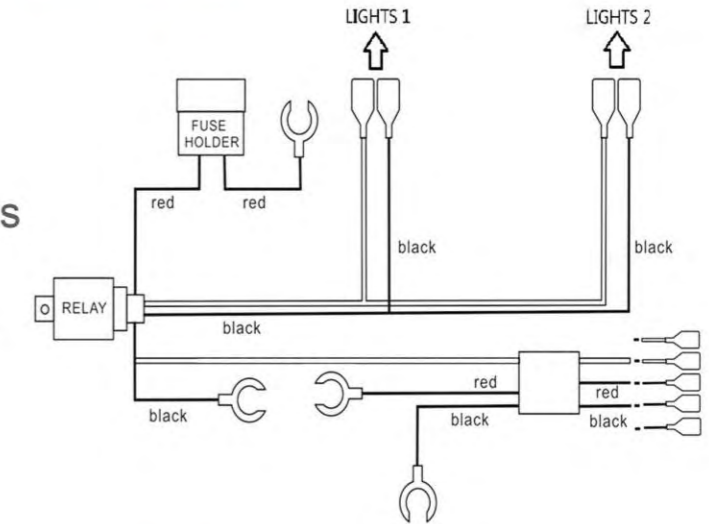

ACCESSORIES



- ① Mounting Panel End
- ② Mounting Panel Middle
- ③ Single Mounting Panel
- ④ 8P Connectors
- ⑤ 10 Connectors
- ⑥ 12P Connectors
- ⑦ Hole Plug
- ⑧ Actuator Removal Tool



Laser Symbols Option : LJ Series



Laser Symbols option : JJ Series



Printing Symbols: J Series



USB Power Port

Application

USB car charger, suitable for all DC12V-24V motor vehicles and related equipment, for your mobile phone, Ipad, laptop, navigator, MP3, MP4, mobile power, game console, music player, etc. with USB interface digital Electronic product charging.



DSA01 (60/30cm)



DSA02 (60/30cm)



DSA03 (20cm)

Model Description: DS018B-TEB4.2AX/Pa

DS	002	B-	T	E	B	4.2A	X	/Pa
Model	Type	Switch type	Led type	LED color	Total current	Mounting	Housingcolor	
001	A: Bus USB	():Common	E:Ring	B:Blue	1A	():PIN	(Pa): Plastic Black	
002	B:Round Plastic USB	T: Touch type	D:Dot	R: Red	2.1A	X: Wired	Pw: Plastic White	
003	C: Cigarettelighter	S: Buttons witch	W: Non-illuminated	G:Green	2.4A		Aa:Al Black	
004	G: Power socket			W: White	3.1A		Ar: Al Red	
.....	R: Rocker USB			Y: Yellow	4.2A		Ay: Al Yellow	
	F: Mobilephoneholder	C:Rechargeable phoneholder			4.8A		Ab: Al Blue	
	M:Motorcycl&USB	A:Non rechargeable phoneholder					Ag: Al Green	
	V: Digitaldisplaymeter							
	L: Metal USB							



DS004A01(PD+QC3.0)
DS004A02(2.4+2.4A)

DS005A
3.1A

DS006A
4.8A

DS007A
2.4A



DS001A

Bus USB3.1A
Input:12-24V
Output:5V/1A+5V/2.1A



DS001A-S

Bus USB3.1A With switch
Input:12-24V
Output:5V/1A+5V/2.1A



DS002A

Bus 2*QC3.0
Input:12-24V
Output:QC3.0+QC3.0
QC3.0:5V 3A, 9V 3A, 12V 3A



DS002A-S

Bus 2*QC3.0 With switch
Input:12-24V
Output:QC3.0+QC3.0
QC3.0:5V 3A, 9V 3A, 12V 3A



DS003A

Bus QC3.0+PD3.0
Input:12-24V
Output:QC3.0+PD3.0
QC3.0:5V 3A, 9V 3A, 12V 3A
PD:55W (12V/27W, 24V/55W)



DS003A-S

Bus QC3.0+PD3.0 With switch
Input:12-24V
Output:QC3.0+PD3.0
QC3.0:5V 3A, 9V 3A, 12V 3A
PD:55W (12V/27W, 24V/55W)



DS001B
1A Single USB

Input: DC12-24V
USB output: 5V 1A
Material: PA+hardware
Product Size: 37*29*53mm
USB output selection: 2.1A/QC3.0
Light color: RD/BU/WH/GN/OG



DS002B
QC3.0 Quick Charge
Single USB

Product Size: 37*43*29mm
Light color: BU



DS003B
Laser 2.1A Single USB

USB output: 5V 2.1A
Product Size: 37*29*53mm
USB output selection: 3.1A/QC3.0



DS012B(//A)
QC3.0 Dual USB
(green core)

Product Size: 50*37*29mm
Light color: BU



DS012B-T Touch
QC3.0*2



DS013B-3.1A / 4.2A

3.1A / 4.2A Dual USB+Volt



DS004B
2.1A Single USB

Input: DC12-24V
USB output: 5V 2.1A
Material: ABS/PA+hardware
Product Size: 37*29*53mm
Light color: RD/BU
Shell color: BK/WH



DS005B
Round type-C 24Pin
Single USB Socket

Product Size: 45*36*29mm
Light color: BU



DS006B
New PD Super
Quick-Charger

Product Size: 50.2*36.6*36.6mm
Light color: BU



DS014B
Dual USB

Product Size: 60*50*50mm
Light color: BU



DS015B(//A)
Dual QC3.0+Volt



DS015B-T Touch
QC3.0*2+Volt



DS007B
3.1A Square White

Input: DC12-24V
USB output: 5V 3.1A
Material: PA+hardware
Product Size: 37*29*53mm
USB output selection: 3.1A/4.2A
Light color: BK/WH



DS008B
Laser 3.1/4.2A/4.8A
Dual USB

Input: DC12-24V
USB output: 5V 3.1A/4.2A/4.8A
Material: ABS+hardware
Product Size: 37*29*53mm
USB output selection: 3.1A/QC3.0
Light color: RD/BU/WH/GN/OG



DS008B-T-3.1A/4.2A/4.8A
Touch



DS016B
Cabochon Single
QC3.0

Input: DC12-24V
USB QC3.0 output: 5V 3A/DC9V 2A/
DC12V 1.5A
Voltage test range: 5V-30V
Material: ABS/Aluminum alloy
Product Size: 37*29*53mm
Light color: RD/BU/GN



DS017B
QC3.0 USB Charger
Digital Voltmeter
Ammeter

Product Size: 37*29*53mm
Light color: RD/BU/WH/GN/OG



DS018B
QC3.0+TYPE-C+PD

Input: DC12-24V
USB QC3.0 output: 5V 3A/DC9V 2A/
DC12V 1.5A
Voltage test range: 5V-30V
Material: ABS/Aluminum alloy
Product Size: 37*29*53mm
Light color: RD/BU/GN



DS009B
3A Dual USB

Product Size: 50*37*29mm
Light color: BU



DS010B
2.4A+PD Single USB

Product Size: 37*28*41mm
Light color: BU



DS011B
Laser 2.4A+QC3.0

Input: DC12-24V
USB output: 5V 2.4A
USB QC3.0 output: DC5V 3A/DC9V 2A/
DC 12V 1.5A
Material: ABS+hardware
Product Size: 37*29*53mm
Light color: RD/BU/WH/GN/OG



DS018B-S Switch
QC3.0+PD+Volt



DS019B
USB+PD



DS020B
Dual QC3.0 with Switch
+PD+Volt

Product Size: 50*37*29mm
Light color: BU



DS021B
PD*2+Switch



DS022B
2.4A*2 Rotary cover

DS023B



USB+AUX(Round Single)
Product Size: 37*43mm
Light color: BU



DS033B01(3.1A)
DS033B02(QC3.0*2)
DS033B03(QC3.0+PD)



DS034B01(3.1A)
DS034B02(QC3.0*2)
DS034B03(QC3.0+PD)



DS035B
5V 1A+2.1A



DS024B-T
2.4A*2+Volt+Touch



DS025B
QC3.0 Dual PD+USB
Product Size: 50*37*29mm
Light color: BU

DS026B



3.1A Dual USB
Input: DC12-24V
USB output: 5V 3.1A
Material: plastic+hardware
Product Size: 37*29*53mm
Light color: GY/BK



DS036B
Type A+Type C



DS037B
PD*2+QC3.0



DS038B
PD*2+QC3.0+Volt



DS027B
3.1A Dual USB
Input: DC12-24V
USB output: DC5V 3.1A
Material: ABS+hardware
Product Size: 37*29*53mm
USB output selection: 3.1A/4.2A/QC3.0
Shell color: BK/WH
Light color: RD/BU



DS028B-4.2A/4.8A
2.1A/2.4A*2 Spring cover



DS029B
2.4A+QC3.0
Light color: BU



DS039B
PD60W+2.4A*2



DS040B
PD/60W*2



DS041B
QC4.0*2

DS030B



Input: DC12-24V
USB output: 5V 4.2A
Material: ABS/PA+hardware
Product Size: 37*29*53mm
USB output selection: 3.1A/4.2A
Light color: RD/BU
Shell color: BK/WH



DS031B
QC5.0*2



DS032B
QC4.0+PD4.0



DS042B
QC3.0+QC4.0 Light color: BU



DS043B-S Switch
QC3.0*3



DS044B-S Switch
QC3.0*2+PD



DS048B
 QC3.0+PD(plastic)
 Product Size: 50*36.8*28.5mm
 Light color: BU



DS048B-S Switch
 QC3.0+PD



DS001L
 PD+QC3.0+Volt
 Material:aluminum alloy



DS009L
 QC3.0+PD*2
 Product Size: 36.5*43mm



DS010L
 QC3.0*3
 USB(metal)
 Product Size: 37*68mm
 USB output: 5V/3A 9V/2A 12V/1.5A



DS011L
 QC3.0*2+PD



DS002L
 2.1A*2
 Material:aluminum alloy



DS003L
 QC3.0*2
 Material:aluminum alloy



DS004L
 QC3.0*2+Volt
 Material:aluminum alloy



DS012L Touch
 QC3.0+4.2A



DS001K-S
 QC3.0+Volt+Switch



DS002K-T
 QC3.0*2+Touch



DS004L-T
 QC3.0*2+Volt
 Material:aluminum alloy



DS004L-S
 QC3.0*2+Volt
 Material:aluminum alloy



DS005L
 2.1A*2
 Material:aluminum alloy



DS003K-T
 QC3.0+PD+Touch



DS004K-T
 4.8A+Touch



DS005K-T
 QC3.0+PD+Volt



DS006L
 QC3.0*2
 Material:aluminum alloy



DS007L
 1A+2.1A
 Material:aluminum alloy



DS008L
 QC3.0+3.1A



DS006K-T
 QC3.0+PD



DS2013
 3.1A Dual USB
 Input: DC12-24V
 USB output: 5V 3.1A
 Material: PA+hardware
 Product Size: 37*29*53mm
 USB output selection: 3.1A/4.2A
 Light color: RD/BU/WH/GN/OG



Touch
DS2013-T-3.1A/4.2A

ROCKER TYPE POWER SOCKET

Allows drivers to charge their digital devices like smartphone, and PC tablets. Connect the cable to the USB port, charging will begin.



DS001R01
12-24V,BU/RD/GN



DS001R02
12-24V,BU/RD/GN



DS002R
3.1/4.2/4.8A
4.2A Dual USB(Switch type)
Input: DC12-24V
USB output: DC5V 4.2A
Material: ABS+hardware
Product Size: 25.4*53.4*50.8mm
USB output selection: 3.1A/4.2A/
4.8A/QC3.0
Light color: RD/BU/GN/WH/OG

www.welfnobl.com



DS003R
QC3.0*2



DS004R
4.8A+V



DS005R
QC3.0+PD



DS006R
5V 4.8A



DS007R
PD+4.8A



DS008R
3.1/4.2A



DS009R
2.1A+AUX



DS010R
QC3.0+PD+Volt



DS011R
QC3.0*2+Volt



SAFEGUARD



STRONG



CONFIGURATION



CHARGE



OPERATION

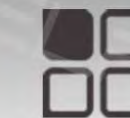

FULL RANGE

www.welfnobl.com

DIGITAL DISPLAY METER SERIES

Intelligent digital display, real-time monitoring
High-quality onboard voltmeter



DS001V

DS002V-T Touch

This is a high-quality voltmeter for checking the state of your battery and battery charger.
The state of your battery between fully charged and discharged.
The voltmeter and USB fast-charge function are your best choice.

www.welfnobl.com



DS002V



DS003V



DS004V



DS005V



DS006V



DS007V



DS008V



DS009V



DS010V



DS011V



DS012V



DS013V

www.welfnobl.com



DS014V



DS015V



DS016V



DS205V



DS206V



DS207V



DS017V-S



DS018V-S



DS019V-S



DS208V



DS209V

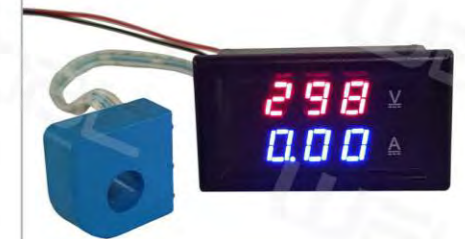

DS210V



DS020V



DS021V



DS201V



DS211V



DS212V



DS213V



DS202V



DS203V



DS204V



DS214V



DS215V



DS216V



DS217V

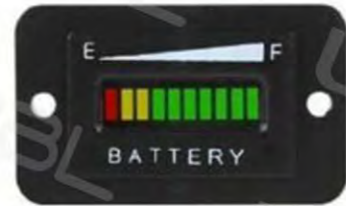

DS218V



DS219V



DS220V



DS221V

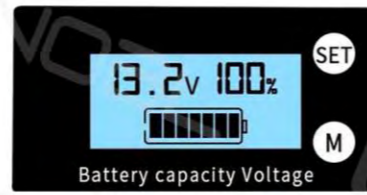

DS222V

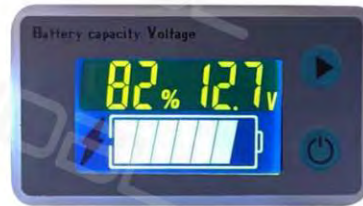

DS223V



DS4010



DS4010-L



DS4010-E



DS7010



DS8010

POWER SOCKET CIGARETTE LIGHTER SOCKET SERIES

Supports charging of in-vehicle devices such as navigation devices, electronic dogs, event data recorder USB devices, etc.



DS3004(Big)



**DS3004-B
(Housing)**



**DS3004-A
(Lighter)**



DS017G
Input:DC 12-24V
Material:ABS+Copper
OD:4.2mm



DS018G
Input:DC 12-24V
Material:ABS+Copper
Wire length:1m



DS019G
Input:DC 12-24V
Material:ABS+Copper
OD:0.3mm



DS3004-2(Small)



**DS3004-2B
(Small housing)**



DS010G
Input:DC 12-24V
Material:ABS+Copper



DS020G
Input:DC 12-24V
Material:ABS+Copper
Wire length:0.48m



DS021G
Input:DC 12-24V
Material:ABS+Copper
Wire length:3m



DS022G
Input:DC 12-24V
Material:ABS+Copper
Wire length:3m



DS011G
Input:DC 12-24V
Material:ABS+Copper



DS012G
Input:DC 12-24V
Material:ABS+Copper



DS013G
Input:DC 12-24V
Material:ABS+Copper



DS023G
Input:DC 12-24V
Material:ABS+Copper



DS024G
Input:DC 12-24V
Material:ABS+Copper



DS025G
Input:DC 12-24V
Material:ABS+Copper



DS014G
Input:DC 12-24V
Material:ABS+Copper



DS015G
Input:DC 12-24V
Material:ABS+Copper
Light Color:RD



DS016G
Input:DC 12-24V
Wire length:1.5m



DS026G
Input:DC 12-24V
Material:ABS+Copper
Wire length:1m



DS027G
Input:DC 12-24V
Material:ABS+Copper
Wire length:1.3m



DS028G
Input:DC 12-24V
Material:ABS+Copper
Wire length:1.2m



DS5015

Input: DC 12-24V
Output: 5V/5A/120W
Material: ABS+Copper
Hole size: 29mm(Dia)
Size: 37*40mm



DS6036

Input: DC 12-24V
Output: 5V
MAX Amps: 12V/20A/24V/10A
Maximum power: 300W
Material: ABS+Copper
Hole size: 16mm(Dia)
Size: 24*24*41mm



DS9019



DS1011

Input: DC 12-24V
Output: 12V/10A/180W
Material: ABS+Copper
Size: 21*40mm

DS1011D



Input: DC 12-24V
Output: 5V
MAX Amps: 12V/15A/24V/10A
Maximum power: 240W
Material: ABS+Copper
Hole size: 29mm(Dia)
Size: 37*37*56mm
Light color: B G R



DS001G01

Input: DC 12V
MAX Amps: 10A
Maximum power: 120W
Material: ABS+Copper
Hole size: 25mm(Dia)



DS002G



DS003G



DS004G

Input: DC 12-24V
Output: 5V/3.1A
Material: ABS+Copper
Size: 35*53mm



DS005G

Input: DC 12-24V
Output: 12-24V/20A/240W
Material: ABS+Copper



DS006G

Input: DC 12-24V
MAX Amps: 12V/20A/24V/10A
Output power: 120W
Material: ABS+Copper
Size: 85*46*56mm
Net weight: 100g



DS007G

Input: DC 12V
Output power: 120W
MAX Amps: 10A
Material: ABS+Copper
Size: 52*52mm



DS008G

Input: DC 12-24V
Output: DC 12V
Maximum power of cigarette lighter: 150W
Color: BU/YE/GN/RD



DS009G

Input: DC 12-24V
Material: ABS+Copper



DS0010

Standard nut



DS0020

Material: ABS



DS0040

Cylinder quick nut

PANEL ACCESSORIES

Many choices for you
Welcome to customize your switch panel



DS24
Material: ABS
Size: 150*105mm
Hole size: 29mm



DS25



DS26
Material: ABS
Size: 75mm



DS3
Material: ABS
Size: 55*50*80mm
Hole size: 29mm
Color: BK/WH/Beige



DS6
Material: ABS
Size: 98*50*80mm
Hole size: 29mm
Color: BK/WH/Beige



DS9
Material: ABS
Size: 150*50*80mm
Hole size: 29mm
Color: BK/WH



DS21
Material: ABS
Color: BK/GY/BU



DS20
Material: ABS
Net weight: 42g



DS1
Front One hole



DS4
Front Two hole



DS22
Material: ABS
Color: BK/GY/BU

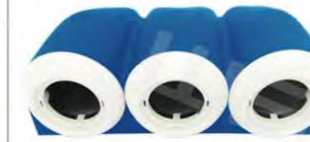

DS23
Material: ABS
Color: BK/GY/BU



DS10-2013
Material: ABS
Size: 98*55*82mm
Hole size: 29mm
Color: YE



DS11
Aderson One Hole Tent
Material: ABS
Color: BK/WH



DS7
Front Three hole



DS2 Rear One hole
Material: ABS
Size: 61*43*5mm
Hole size: 29mm



DS5 Rear Two hole
Material: ABS
Size: 104*45*5mm
Hole size: 34mm



DS12
Aderson Two Hole Tent
Material: ABS



DS13
Aderson Three Hole Tent
Material: ABS
Color: BK/WH



DS14
Special Three Hole Tent
Material: ABS
Color: BK/WH



DS15
Special Two Hole Tent
Material: ABS
Color: BK/WH



DS8 Rear Three hole
Material: ABS
Size: 150*43*5mm
Hole size: 29mm



DSK
Material: ABS
Size: 196*43*5mm
Hole size: 29mm



DSJ
Material: ABS
Size: 105*87*5mm
Hole size: 29mm



DS16
Aderson Square and Round Hole Tent
Material: ABS



DS17
New One Hole Tent
Material: ABS
Color: BK/WH



DS18
New Two Hole Tent
Material: ABS
Color: BK/WH



DS19
50A Aderson One Hole Tent
Material: ABS
Type: One Hole/Two Hole

ROCKER SWITCH PANEL

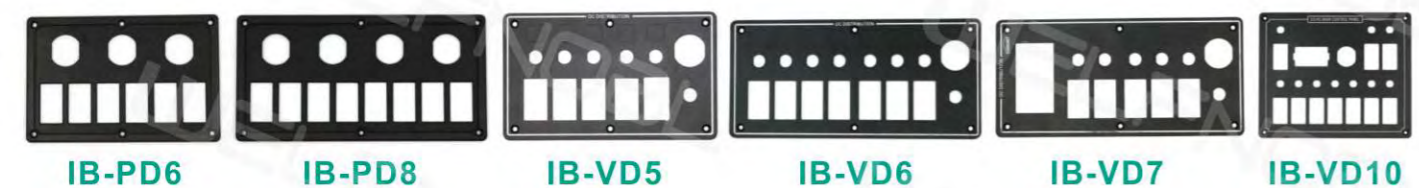
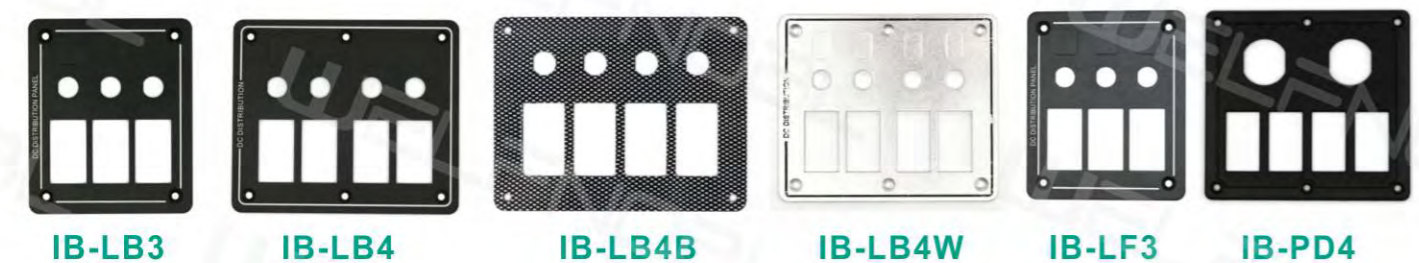
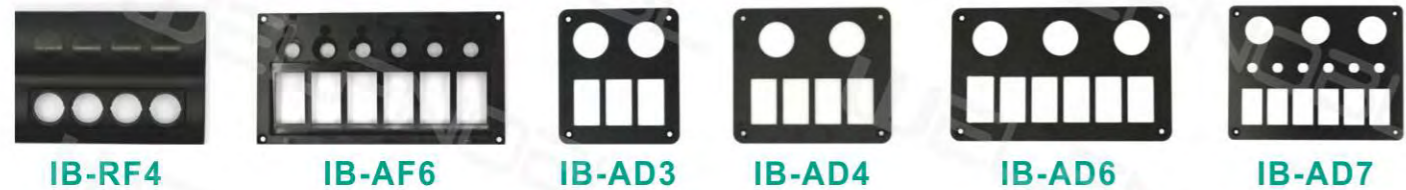

SWITCH PANEL





IB-PN04



IB-PN05



IB-PN06



IB-P306



IB-P307



IB-P308



IB-P101



IB-P201



IB-P202



IB-P309



IB-P310



IB-P311



IB-P203



IB-P301



IB-P302



IB-P401



IB-P402



IB-P403



IB-P303



IB-P304



IB-P305



IB-P404



IB-P405



IB-P406



IB-P407



IB-P408



IB-P409



IB-P505



IB-P506



IB-P507



IB-P410



IB-P411



IB-P412



IB-P508



IB-P509



IB-P510



IB-P413



IB-P414



IB-P501



IB-P511



IB-P512



IB-P513



IB-P502



IB-P503



IB-P504



IB-P514



IB-P601



IB-P602



IB-P603



IB-P605



IB-P606



IB-P616



IB-P617



IB-P701



IB-P607



IB-P608



IB-P609



IB-P702



IB-P703



IB-P704



IB-P610



IB-P611



IB-P612



IB-P705



IB-P706



IB-P801



IB-P613



IB-P614



IB-P615



IB-P802



IB-P803



IB-P804



IB-P805



IB-P806



IB-P807 4.2A



IB-P905



IB-P906



IB-P1001



IB-P808 4.8A



IB-P809



IB-P810



IB-P1002



IB-P1101



IB-P1102



IB-P811



IB-P812



IB-P901



IB-P1103



IB-P1104



IB-P1201



IB-P902



IB-P903



IB-P904



IB-P1202



IB-P1601



IB-P2001



IB-SP101



IB-SP102



IB-SP201



IB-SP401



IB-SP402



IB-SP601



IB-SP202



IB-SP203



IB-SP204



IB-SP602



IB-SP801



IB-SP802



IB-SP205



IB-SP301



IB-SP302



IB-SP1301
12V Control Box



IB-SP1302
Solar-Power Control Box



IB-SP303



IB-SP304



IB-SP305



IB-SP1303
Mini Control Box



IB-SP1401
Control Box with 6 Gang Panel

RACING SWITCH PANEL SERIES

Rev up your racing experience with the cutting-edge Racing Switch Panel



KN-45C



IBA-07D



IB-ESS01



IB-PR01



IB-PR02



IB-PR03

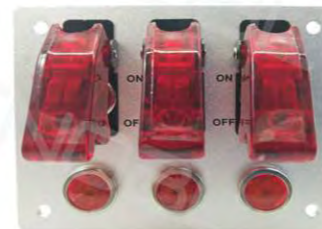

IB-PR04



IB-PR05



IB-PR06



IB-PR07

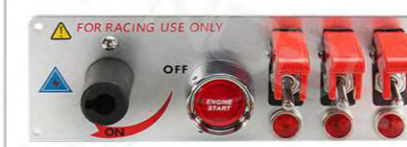

IB-PR08



IB-PR09



IB-PR10



IB-PR11



IB-PR12



IB-PR13



IB-PR14



IB-PR15



IB-PR16



IB-PR17



IB-PR18



IB-PR19



IB-PR20



IB-PR21



IB-PR22



IB-PR23



IB-PR24



IB-PR25



IB-PR26



IB-PR27

Multifunctional Jeep Wrangler Combination Switch Panel Series

Different types of control panels
Multi current protection relay fuse box



IB-PJ1001
Long-Battery Box

PD:18W
QC:18W
Anderson:50A
Size:240*112*60mm